

Hello, I've arrived!

Now that I'm here you are only one flat-pack away from transforming your home.

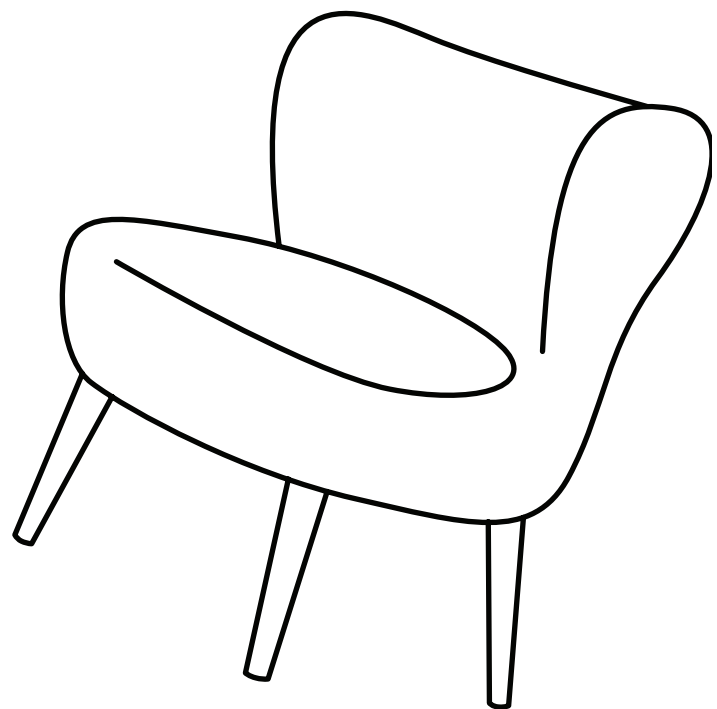
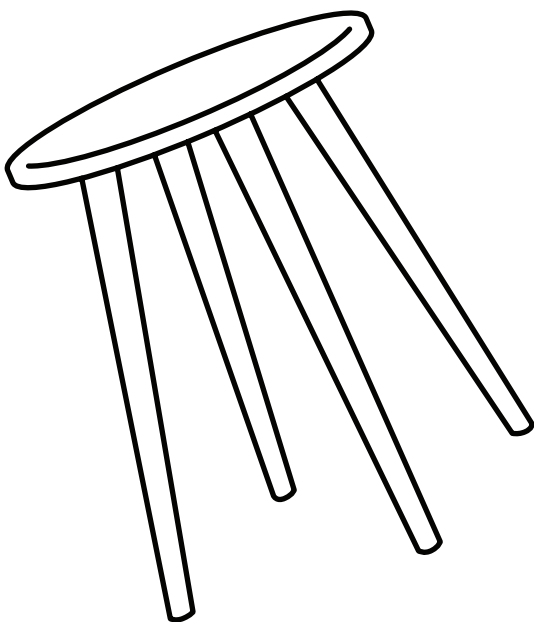

Mocka.

Thank you for supporting us.

We believe design belongs to everyone. From materials and processes to safety testing, production and delivery, we are passionate and committed to bringing you the best possible product so you can create beautifully functional spaces to feel comfortably you.

Here are a few assembly tips before you get started:



Make Time

The first step to all seamless assembly is taking a moment to carefully read through the instructions—you are already on your way to creating a beautifully functional space!



Set The Mood

Put on your favourite playlist, order that pizza and pour yourself a drink to get in the mood!



Tool Check

Layout the instructions, screws and panels to check you have everything you need. A blanket or soft floor rug will help protect your new favourite item from scratches and a drill will speed up the assembly too!



Room Reveal

You did it! Take a step back and enjoy the moment. Don't forget to recycle any packaging and share a pic of your room reveal—we love seeing how you transform your home! **Tag us @mockaaustralia/@mockaanz**

Happy flat-packing!

The Mokka Team

Junior

Metal chair

Thank you for your purchase. Please follow the instructions for correct assembly. While we took great effort to ensure these assembly instructions were correct at the time of printing, sometimes updates are required post production. For the most up to date versions please refer to the product page on our website. mocka.com.au/mocka.co.nz

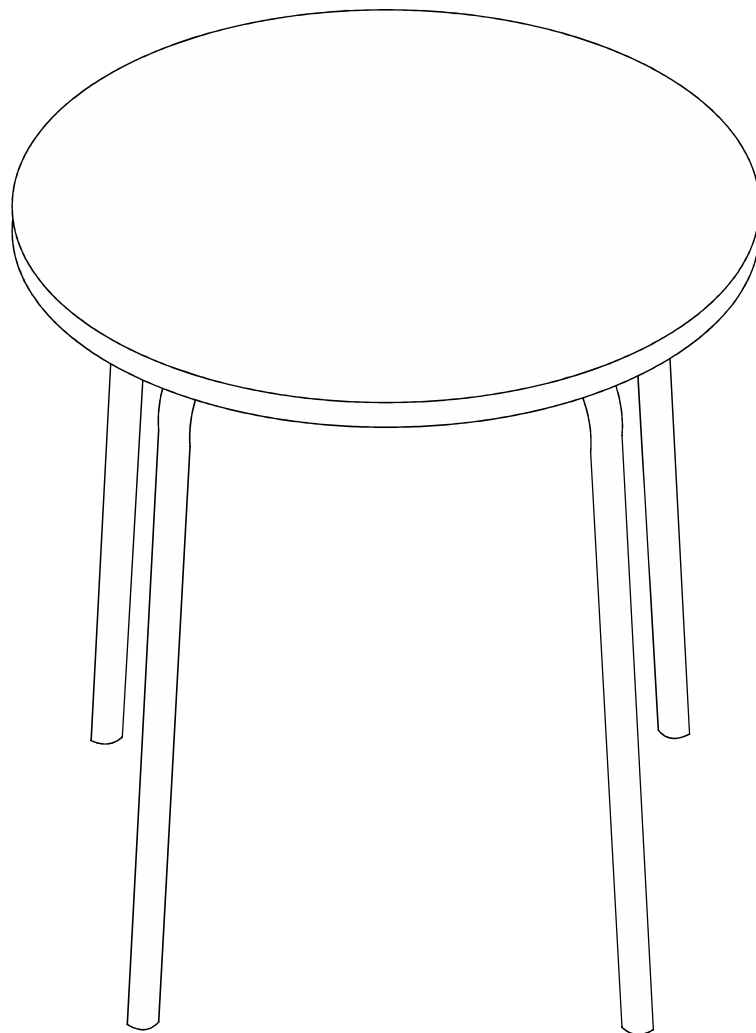

Junior

Metal chair

Panel Layout

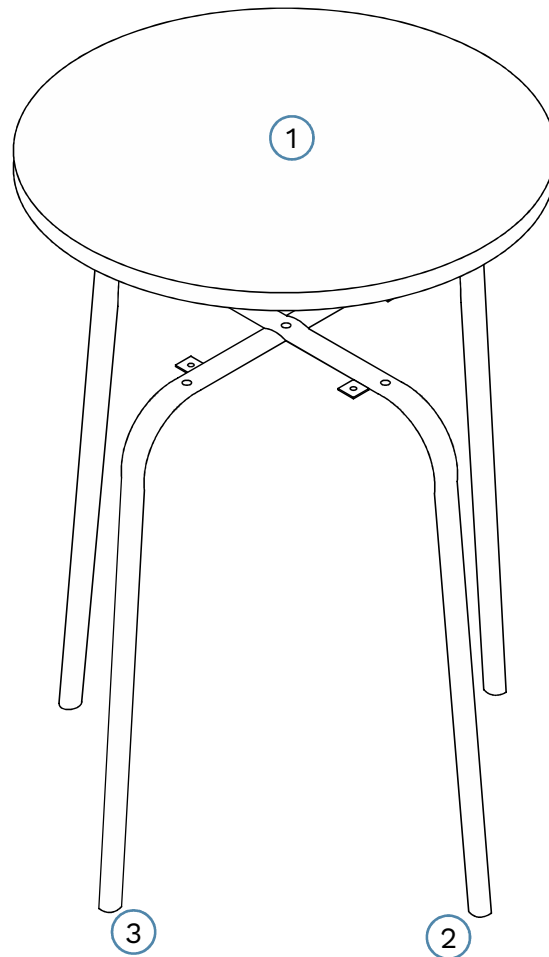

Partlist

①	Panel	x1
②	Legs	x1
③	Legs	x1

Junior

Metal chair

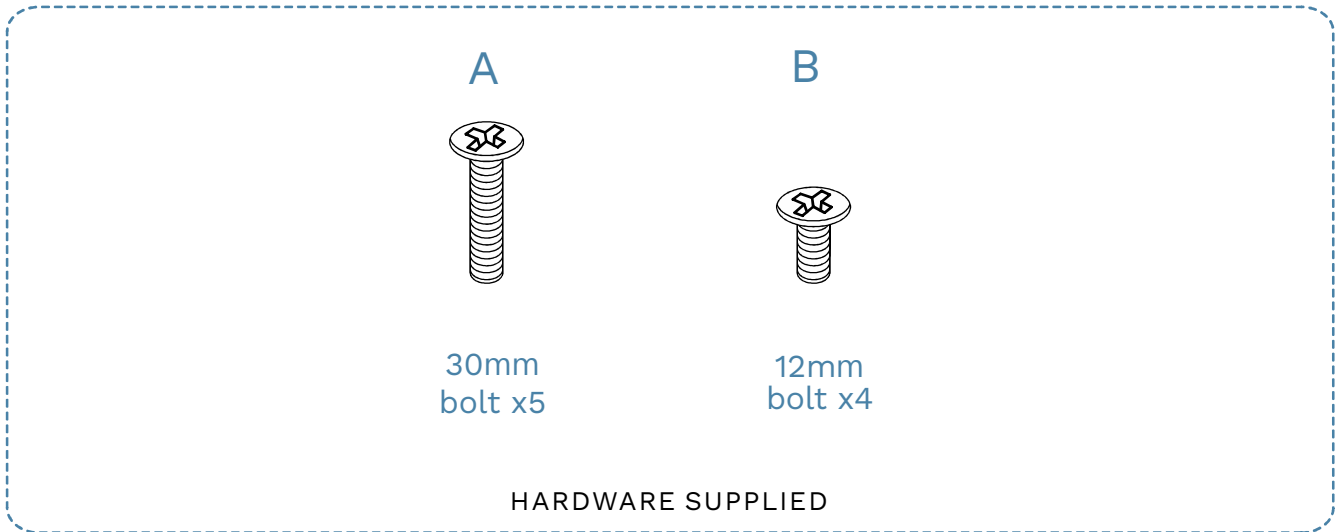

WARNING: Any furniture that is not anchored to a wall has the potential to tip over in certain circumstances, i.e. if a child attempts to climb up on the furniture or in the event of an earthquake. Accordingly, we recommend that all furniture is anchored to a wall. We supply a free safety wall anchor with all furniture sold and we recommend these are used to prevent your product tipping. The fixing device provided should fit most wall types, but please note that different wall materials may require different fixing devices from those supplied.

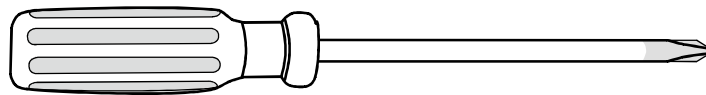



Phillips screwdrivers required.

For quicker assembly, we recommend the use of a power drill on a low-speed setting.

Junior Metal chair

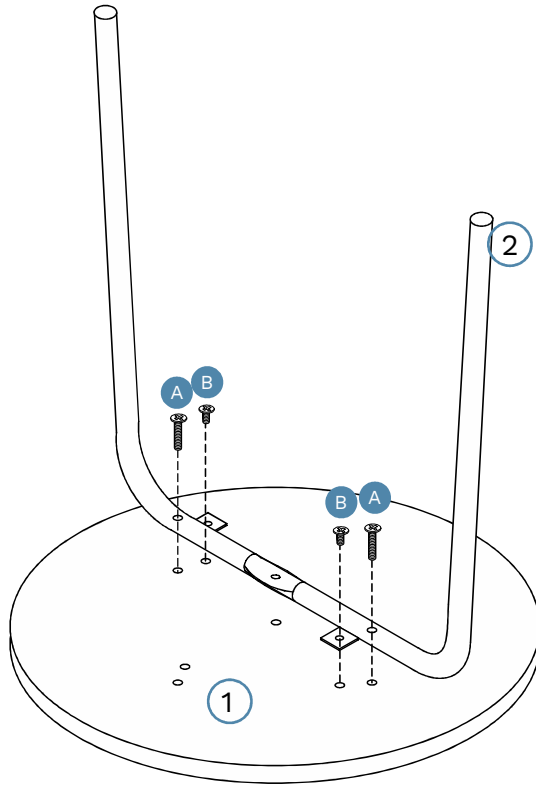
1



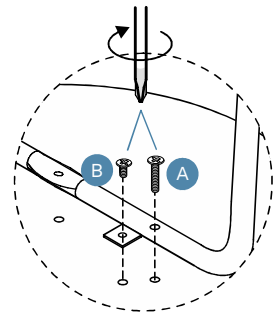

Hardware Needed		
A		x2
B		x2

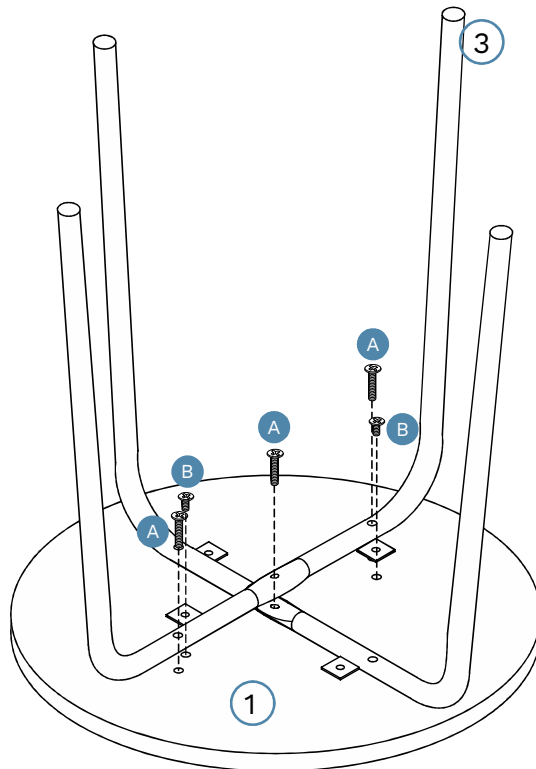

2



Hardware Needed		
A		x3
B		x2

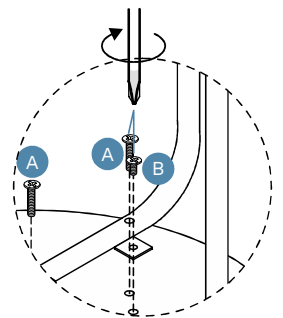

Junior

Metal chair

3

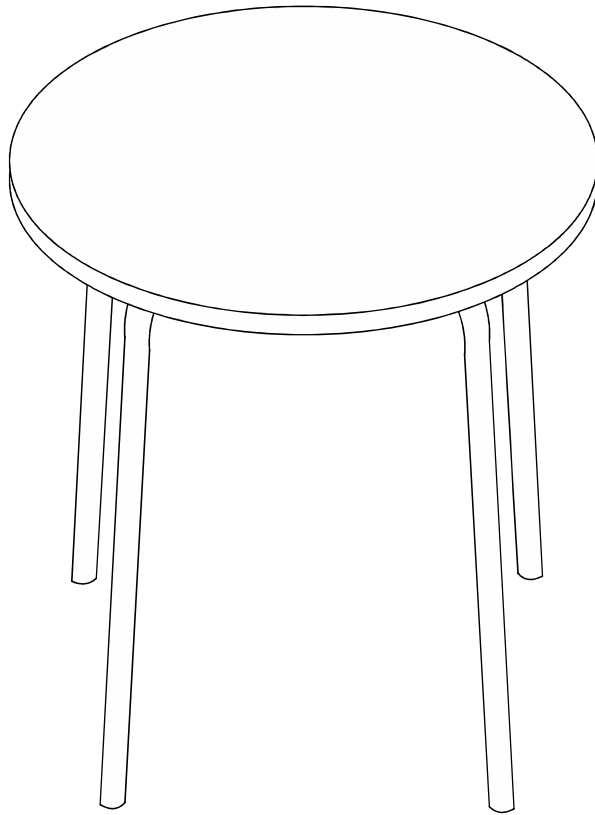

Once assembled lift furniture into place, do not drag. You're done, enjoy!